

GHNbasic II НАСОСЫ

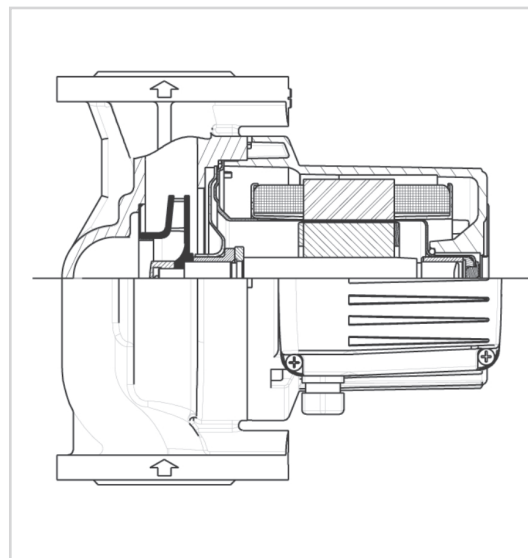

Материал

Корпус	чугун катафорезное покрытие
Рабочее колесо	нержавеющая сталь AISI 316
Вал	нержавеющая сталь AISI 316
Подшипники	графит
Корпус ротора	нержавеющая сталь AISI 316

Технические характеристики

Q	10 - 75 м ³ /h
H	3,5 - 19,5 м
p	PN 6/10, PN6, PN10 bar
DN	40/50/65/80/100
Монтажная длина	250/280/340/360 mm
Монтаж	фланцы
Класс изоляции	200
Степень защиты	IP 44
Напряжение	3 ~ 400V

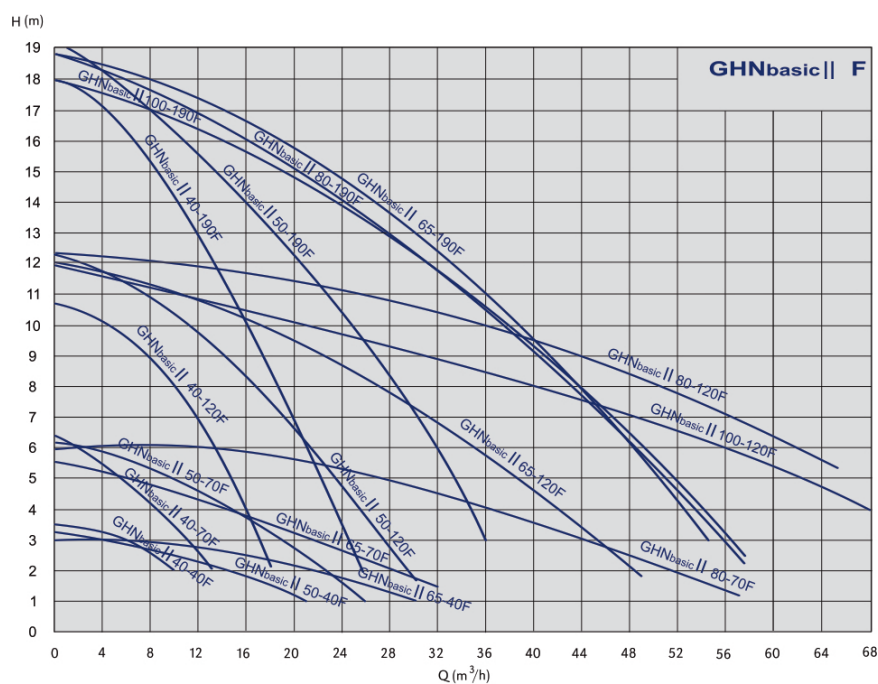

Код	Тип	Q	H	PN (bar)	Вес нетто (kg)
979524575	GHNbasic II 40-190F	27	18	PN 6/10bar	22
979524461	GHNbasic II 40-120F	20	12	PN 6/10bar	17,9
979524462	GHNbasic II 40-70F	13	6	PN 6/10bar	17,7
979524463	GHNbasic II 40-40F	10	3,5	PN 6/10bar	17,4
979524576	GHNbasic II 50-190F	37	19,5	PN 6/10bar	23,3
979524464	GHNbasic II 50-120F	30	12	PN 6/10bar	24,6
979524465	GHNbasic II 50-70F	25	6	PN 6/10bar	24,3
979524466	GHNbasic II 50-40F	20	3,5	PN 6/10bar	24
979524577	GHNbasic II 65-190F	57	18,5	PN 6/10bar	31,4
979524467	GHNbasic II 65-120F	50	12	PN 6/10bar	30,8
979524468	GHNbasic II 65-70F	35	6	PN 6/10bar	28,6
979524469	GHNbasic II 65-40F	33	3,5	PN 6/10bar	28,6
979524578	GHNbasic II 80-190F PN6	57	18,5	PN 6bar	37
979524580	GHNbasic II 80-190F PN10	57	18,5	PN 10bar	37
979524470	GHNbasic II 80-120F PN6	70	12	PN 6bar	34,2
979524472	GHNbasic II 80-120F PN10	70	12	PN 10bar	34,4
979524471	GHNbasic II 80-70F PN6	60	6	PN 6bar	33,4
979524473	GHNbasic II 80-70F PN10	60	6	PN 10bar	32,8
979524579	GHNbasic II 100-190F PN6	57	18,5	PN 6bar	37
979524581	GHNbasic II 100-190F PN10	57	18,5	PN 10bar	37
979524474	GHNbasic II 100-120F PN6	75	11,5	PN 6bar	38,3
979524475	GHNbasic II 100-120F PN10	75	11,5	PN 10bar	37,5

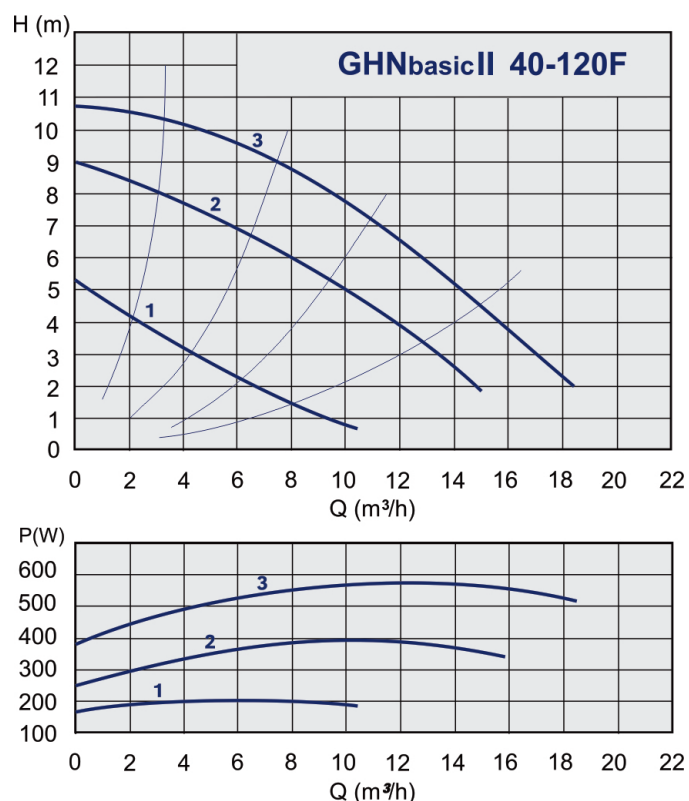
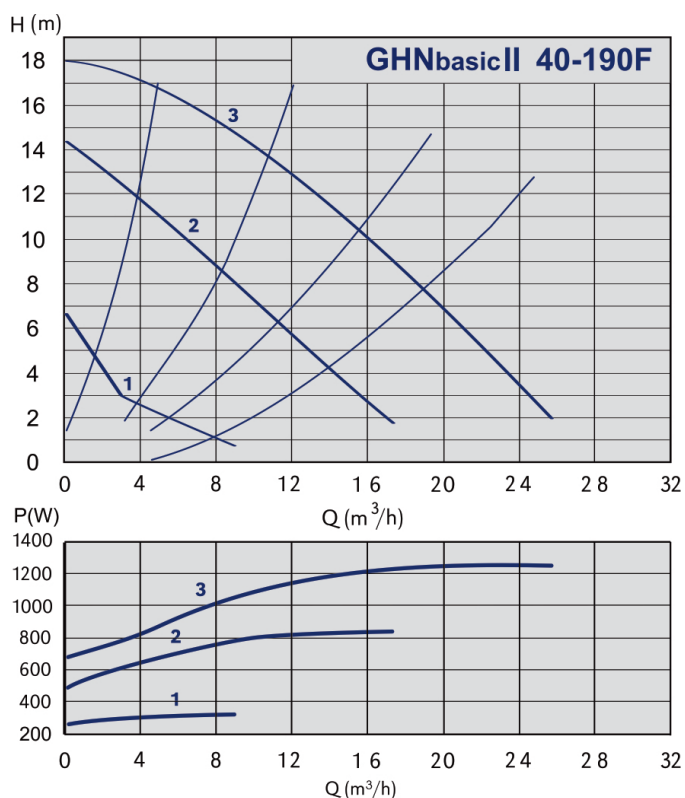

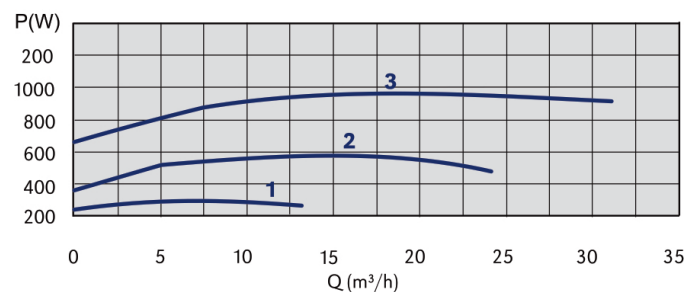
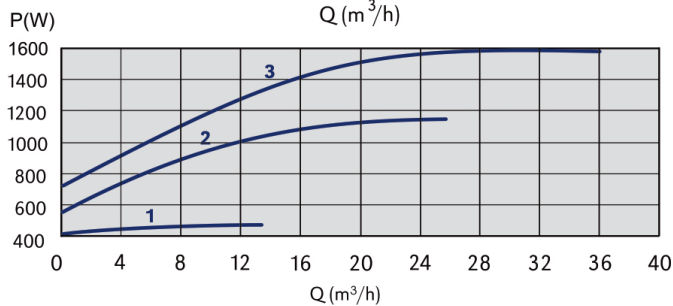
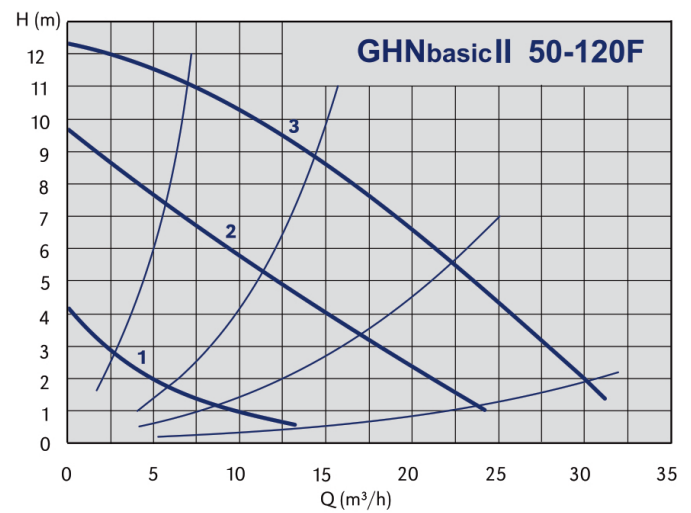
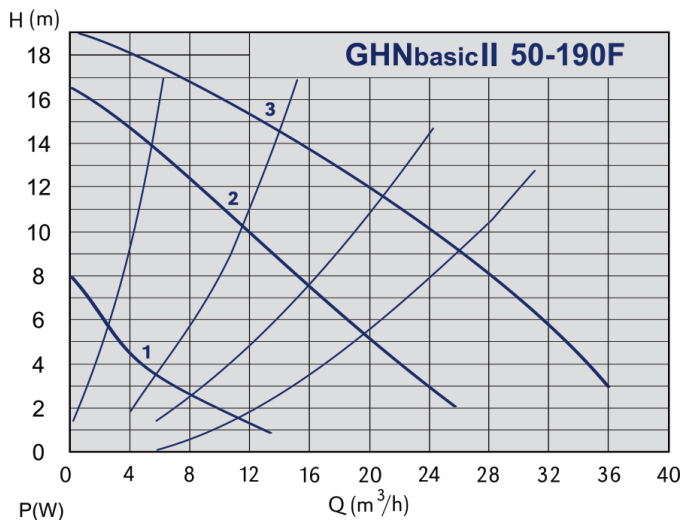
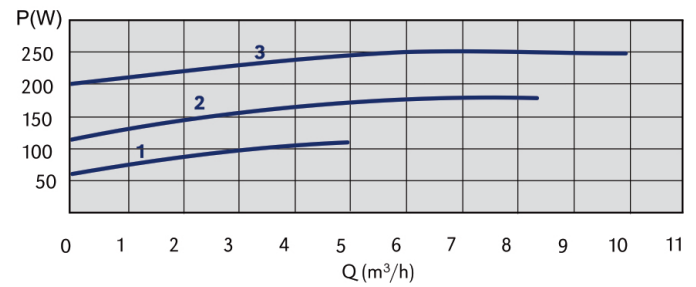
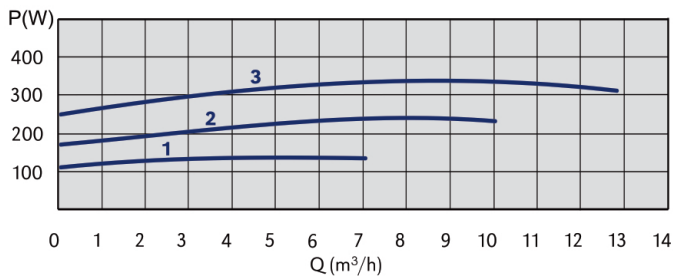
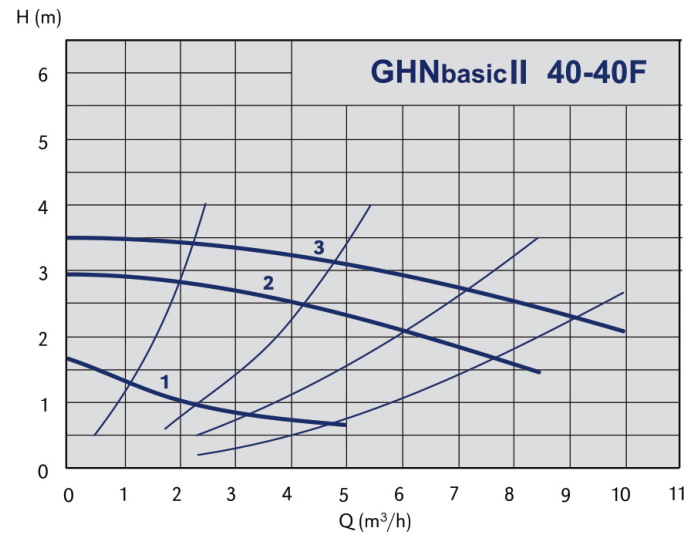
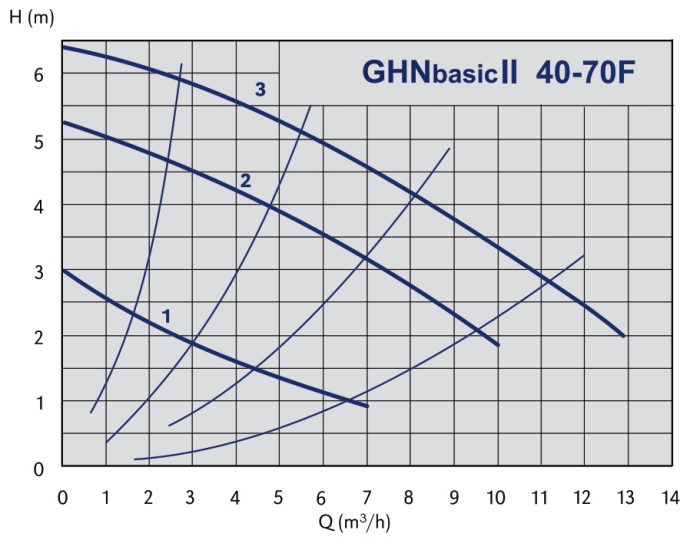

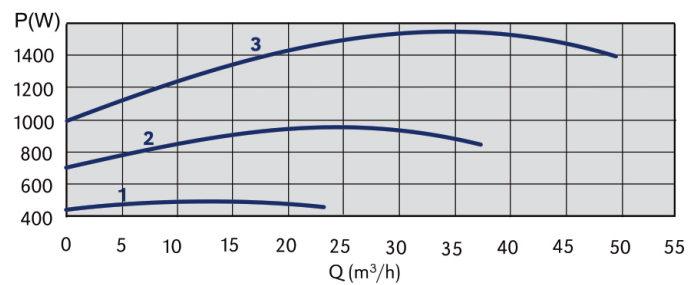
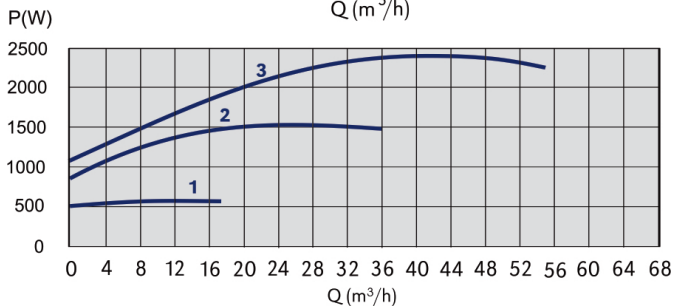
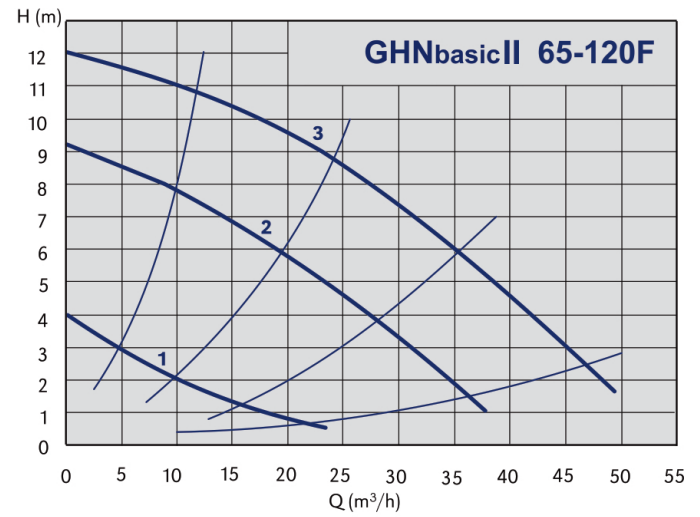
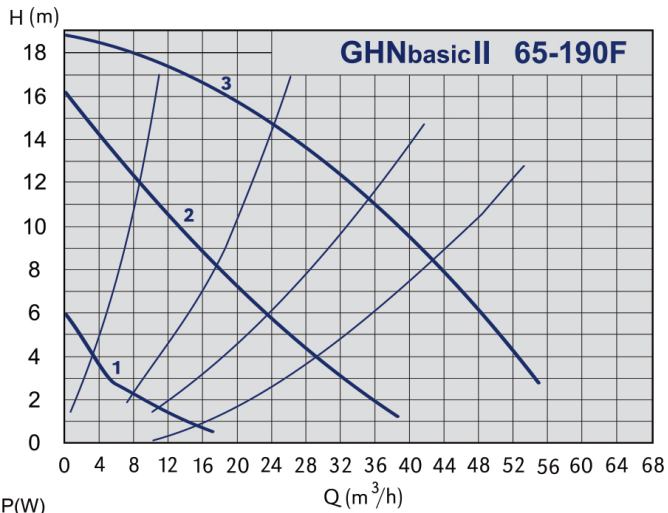
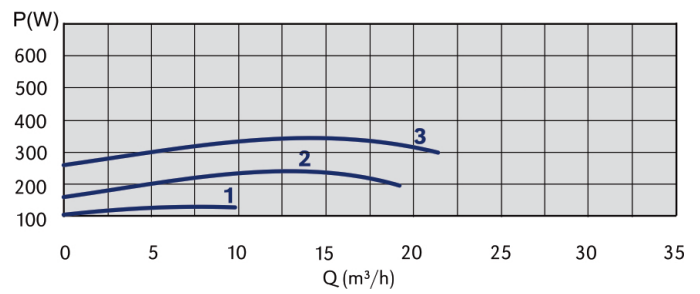
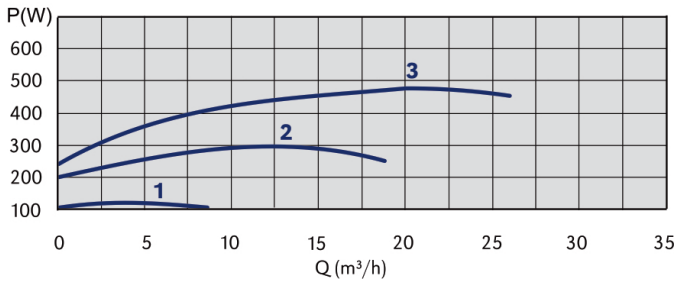
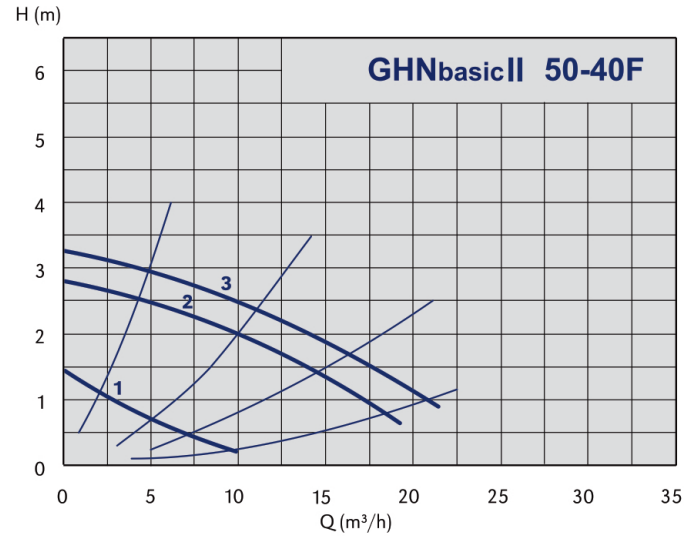
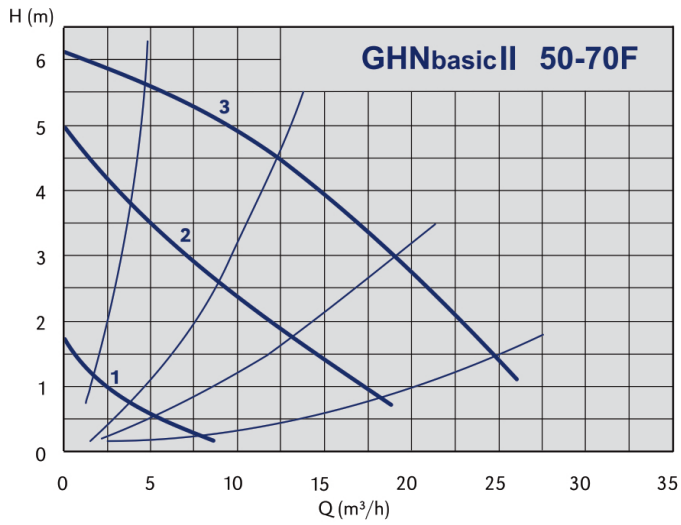

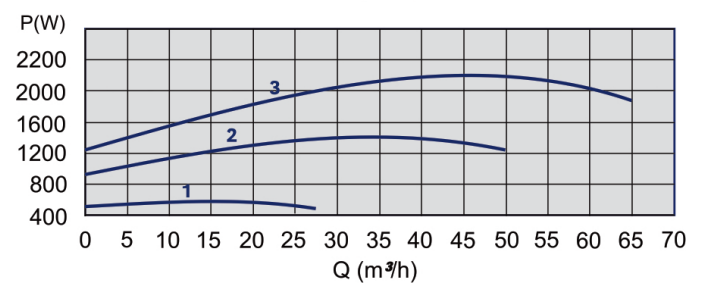
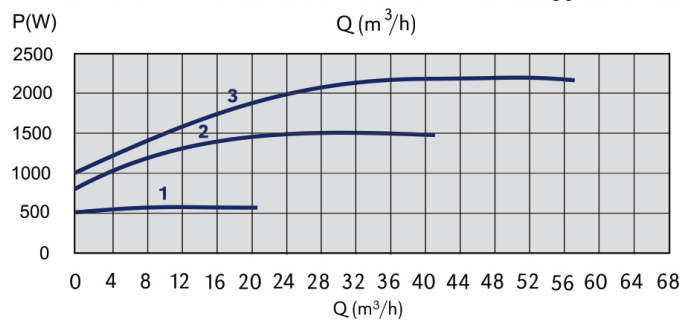
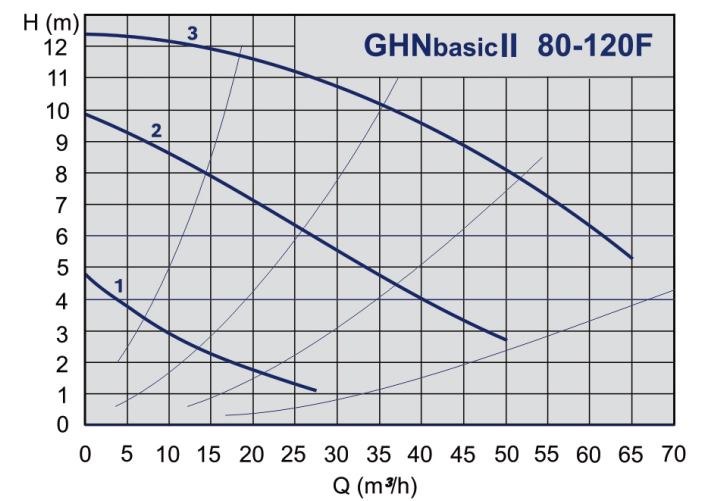
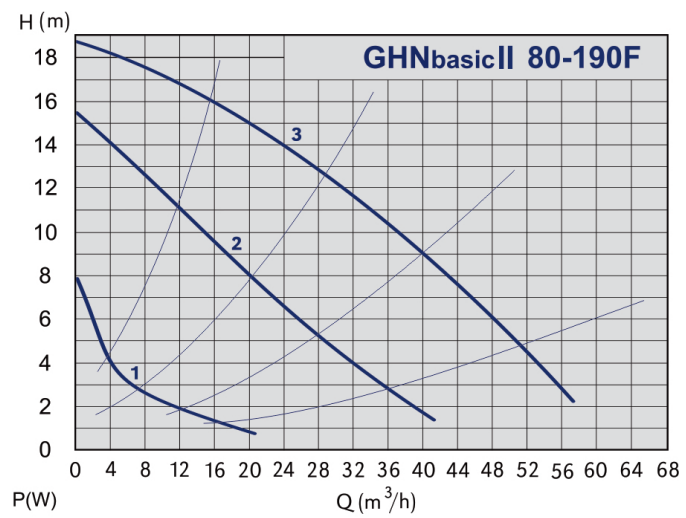
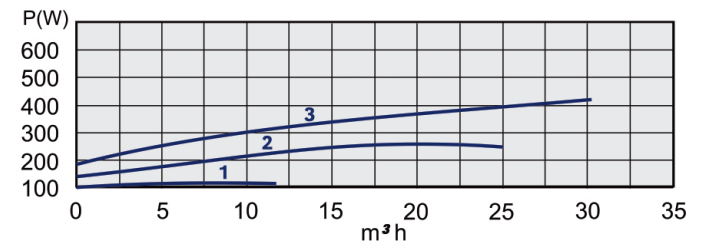
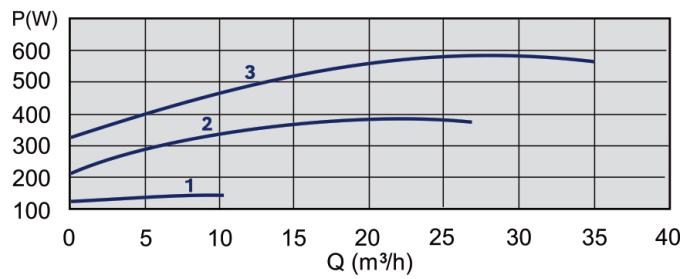
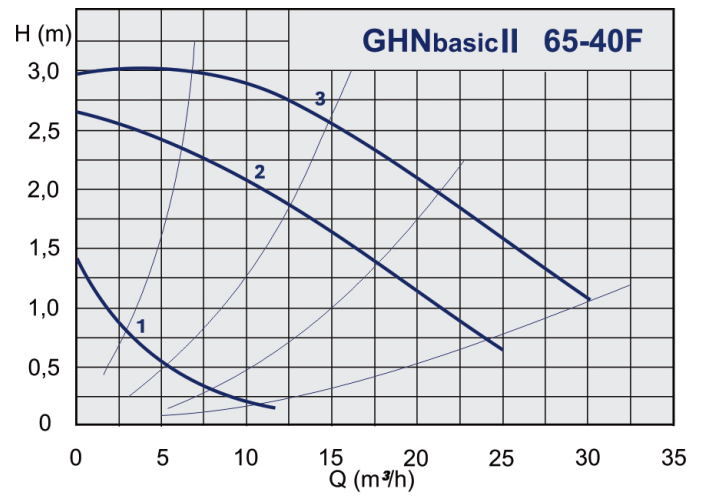
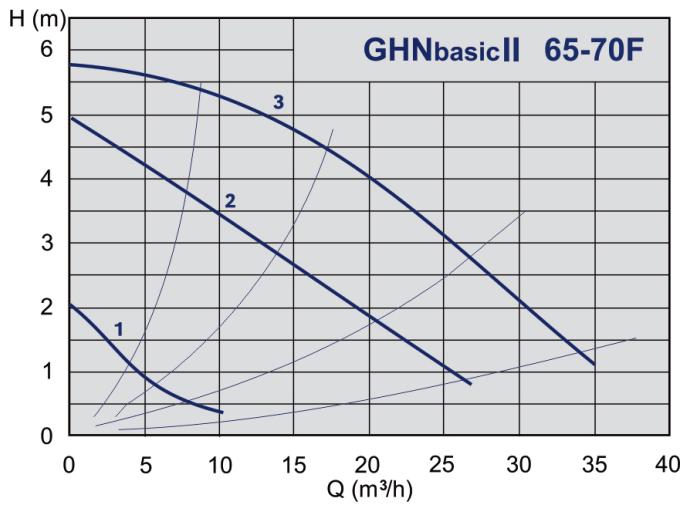

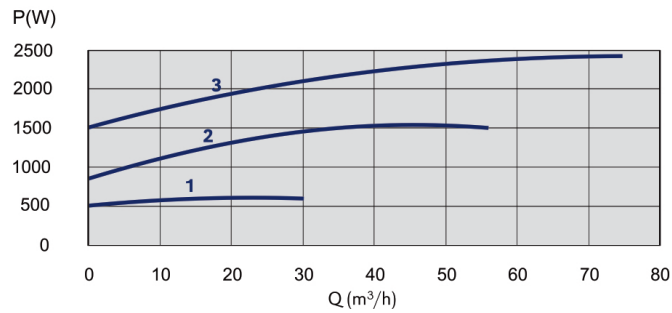
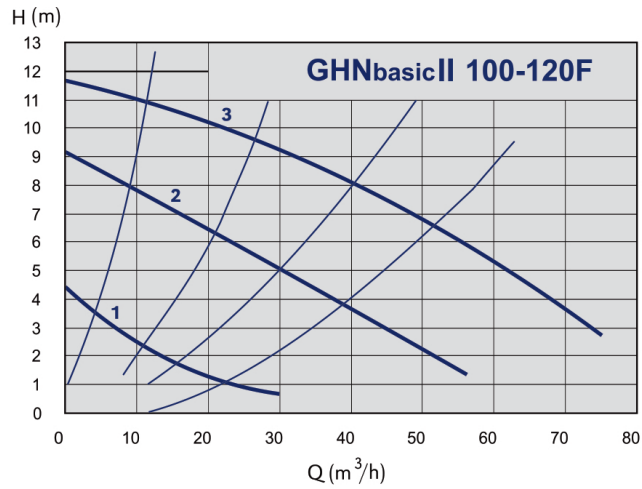
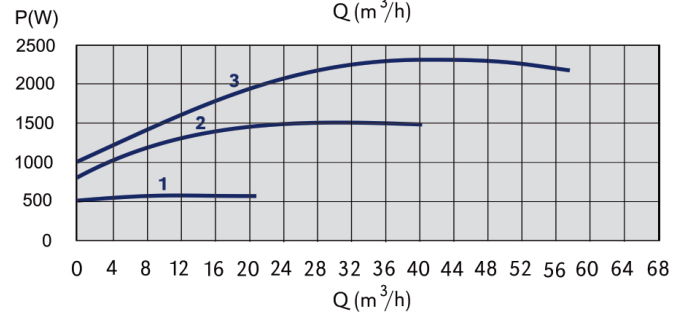
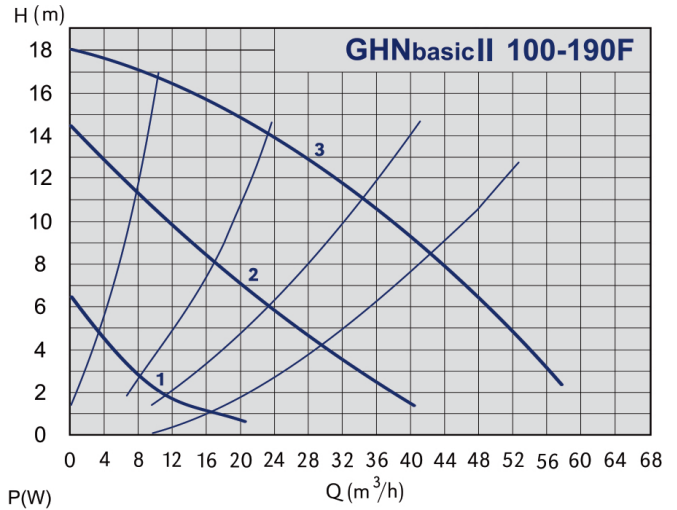
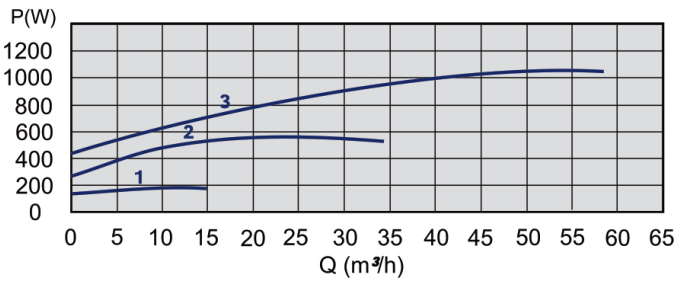
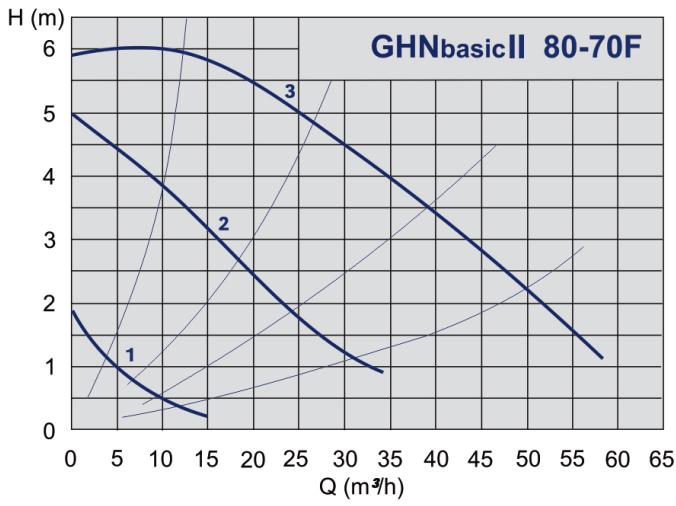

Код	Тип	Монтажная длина [мм]	DN	a	l	b1	b2
979524575	GHNbasic II 40-190F	250	40	65	240	130	92,0
979524461	GHNbasic II 40-120F	250	40	65	198	125	92,0
979524462	GHNbasic II 40-70F	250	40	65	198	125	92,0
979524463	GHNbasic II 40-40F	250	40	65	198	125	92,0
979524576	GHNbasic II 50-190F	280	50	70	250	130	113,0
979524464	GHNbasic II 50-120F	280	50	70	250	130	113,0
979524465	GHNbasic II 50-70F	280	50	70	250	130	113,0
979524466	GHNbasic II 50-40F	280	50	70	250	130	113,0
979524577	GHNbasic II 65-190F	340	65	80	252	130	123,0
979524467	GHNbasic II 65-120F	340	65	80	252	130	123,0
979524468	GHNbasic II 65-70F	340	65	80	252	130	123,0
979524469	GHNbasic II 65-40F	340	65	80	252	130	123,0
979524578	GHNbasic II 80-190F PN6	360	80	100	257	130	130,0
979524580	GHNbasic II 80-190F PN10	360	80	100	257	130	130,0
979524470	GHNbasic II 80-120F PN6	360	80	100	257	130	129,5
979524472	GHNbasic II 80-120F PN10	360	80	100	257	130	129,5
979524471	GHNbasic II 80-70F PN6	360	80	100	257	130	129,5
979524473	GHNbasic II 80-70F PN10	360	80	100	257	130	129,5
979524579	GHNbasic II 100-190F PN6	360	100	110	257	130	130,0
979524581	GHNbasic II 100-190F PN10	360	100	110	257	130	130,0
979524474	GHNbasic II 100-120F PN6	360	100	110	257	130	130,0
979524475	GHNbasic II 100-120F PN10	360	100	110	257	130	130,0

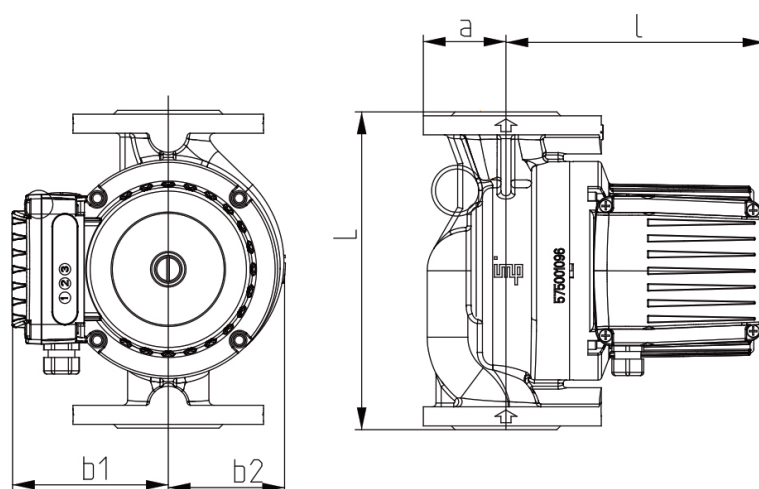

Код	Тип	P _{max} (W)	диапазон скоростей (min ⁻¹)	FLC I In (A)	класс изоляции	мин рабочее давление 50°C	мин рабочее давление 80°C	мин рабочее давление 110°C
979524575	GHNbasic II 40-190F	1260		0,61 - 2,24	200	0,05	0,8	1,4
979524461	GHNbasic II 40-120F	573	1250 - 2820	0,38 - 1,46	200	0,05	0,8	1,4
979524462	GHNbasic II 40-70F	317	1440 - 2790	0,23 - 0,74	200	0,05	0,8	1,4
979524463	GHNbasic II 40-40F	209	660 - 1440	0,12 - 0,70	200	0,05	0,8	1,4
979524576	GHNbasic II 50-190F	1596		0,89 - 2,90	200	0,3	1	1,6
979524464	GHNbasic II 50-120F	1058	1270 - 2800	0,59 - 2,02	200	0,3	1	1,6
979524465	GHNbasic II 50-70F	465	560 - 1400	0,22 - 1,13	200	0,3	1	1,6
979524466	GHNbasic II 50-40F	282	620 - 1450	0,21 - 0,97	200	0,3	1	1,6
979524577	GHNbasic II 65-190F	2346		1,05 - 4,00	200	0,3	1	1,6
979524467	GHNbasic II 65-120F	1522	1250 - 2810	0,89 - 2,83	200	0,3	1	1,6
979524468	GHNbasic II 65-70F	578	450 - 1370	0,31 - 1,50	200	0,3	1	1,6
979524469	GHNbasic II 65-40F	365	600 - 1430	0,21 - 1,05	200	0,3	1	1,6
979524578	GHNbasic II 80-190F PN6	2272		1,08 - 3,90	200	0,3	1	1,6
979524580	GHNbasic II 80-190F PN10	2272		1,08 - 3,90	200	0,3	1	1,6
979524470	GHNbasic II 80-120F PN6	2263	1200 - 2800	1,16 - 3,90	200	0,3	1	1,6
979524472	GHNbasic II 80-120F PN10	2263	1200 - 2800	1,16 - 3,90	200	0,3	1	1,6
979524471	GHNbasic II 80-70F PN6	1002	600 - 1350	0,43 - 2,20	200	0,3	1	1,6
979524473	GHNbasic II 80-70F PN10	1002	600 - 1350	0,43 - 2,20	200	0,3	1	1,6
979524579	GHNbasic II 100-190F PN6	2287		1,07 - 3,90	200	0,3	1	1,6
979524581	GHNbasic II 100-190F PN10	2287		1,07 - 3,90	200	0,3	1	1,6
979524474	GHNbasic II 100-120F PN6	2324	1200 - 2800	1,16 - 4,00	200	0,3	1	1,6
979524475	GHNbasic II 100-120F PN10	2324	1200 - 2800	1,16 - 4,00	200	0,3	1	1,6

